

P-Channel 20-V (D-S) MOSFET

PRODUCT SUMMARY		
V_{DS} (V)	$r_{DS(on)}$ (Ω)	I_D (A)
-20	0.0077 @ $V_{GS} = -4.5$ V	-19
	0.0094 @ $V_{GS} = -2.5$ V	-17
	0.0125 @ $V_{GS} = -1.8$ V	-15

FEATURES

- TrenchFET® Power MOSFET
- New Low Thermal Resistance PowerPAK® Package with Low 1.07-mm Profile
- 100% R_g Tested

APPLICATIONS

- Load Switch Battery Applications

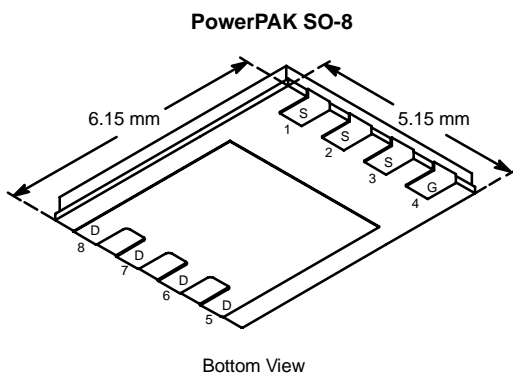

Ordering Information: Si7445DP-T1

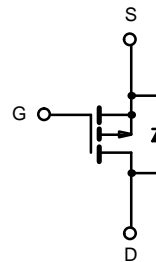

ABSOLUTE MAXIMUM RATINGS ($T_A = 25^\circ\text{C}$ UNLESS OTHERWISE NOTED)				
Parameter	Symbol	10 secs	Steady State	Unit
Drain-Source Voltage	V_{DS}	-20		V
Gate-Source Voltage	V_{GS}	± 8		
Continuous Drain Current ($T_J = 150^\circ\text{C}$) ^a	I_D	$T_A = 25^\circ\text{C}$	-19	-12
		$T_A = 70^\circ\text{C}$	-15	-9
Pulsed Drain Current	I_{DM}	-50		A
continuous Source Current (Diode Conduction) ^a	I_S	-4.3	-1.6	
Maximum Power Dissipation ^a	P_D	$T_A = 25^\circ\text{C}$	5.4	1.9
		$T_A = 70^\circ\text{C}$	3.4	1.2
Operating Junction and Storage Temperature Range	T_J, T_{stg}	-55 to 150		$^\circ\text{C}$

THERMAL RESISTANCE RATINGS				
Parameter	Symbol	Typical	Maximum	Unit
Maximum Junction-to-Ambient ^a	R_{thJA}	$t \leq 10$ sec	18	23
		Steady State	52	65
Maximum Junction-to-Case (Drain)	R_{thJC}	1.0	1.3	$^\circ\text{C/W}$

Notes

a. Surface Mounted on 1" x 1" FR4 Board.

SPECIFICATIONS (T _J = 25 °C UNLESS OTHERWISE NOTED)						
Parameter	Symbol	Test Condition	Min	Typ	Max	Unit
Static						
Gate Threshold Voltage	V _{GS(th)}	V _{DS} = V _{GS} , I _D = -250 μA	-0.45			V
Gate-Body Leakage	I _{GSS}	V _{DS} = 0 V, V _{GS} = ±8 V			±100	nA
Zero Gate Voltage Drain Current	I _{DSS}	V _{DS} = -16 V, V _{GS} = 0 V			-1	μA
		V _{DS} = -16 V, V _{GS} = 0 V, T _J = 70 °C			-10	
On-State Drain Current ^a	I _{D(on)}	V _{DS} ≤ -5 V, V _{GS} = -4.5 V	-40			A
Drain-Source On-State Resistance ^a	r _{DS(on)}	V _{GS} = -4.5 V, I _D = -19 A		0.0064	0.0077	Ω
		V _{GS} = -2.5 V, I _D = -17 A		0.0078	0.0094	
		V _{GS} = -1.8 V, I _D = -10 A		0.0105	0.0125	
Forward Transconductance ^a	g _{fs}	V _{DS} = -15 V, I _D = -19 A		75		S
Diode Forward Voltage ^a	V _{SD}	I _S = -4.3 A, V _{GS} = 0 V		-0.65	-1.1	V
Dynamic^b						
Total Gate Charge	Q _g	V _{DS} = -15 V, V _{GS} = -5 V, I _D = -19 A		92	140	nC
Gate-Source Charge	Q _{gs}			19		
Gate-Drain Charge	Q _{gd}			16.5		
Gate-Resistance	R _g		1	2	3.4	Ω
Turn-On Delay Time	t _{d(on)}	V _{DD} = -15 V, R _L = 15 Ω I _D ≅ -1 A, V _{GEN} = -4.5 V, R _G = 6 Ω		40	60	ns
Rise Time	t _r			45	65	
Turn-Off Delay Time	t _{d(off)}			400	600	
Fall Time	t _f			190	290	
Source-Drain Reverse Recovery Time	t _{rr}		I _F = -4.3 A, di/dt = 100 A/μs		50	

Notes

- a. Pulse test; pulse width ≤ 300 μs, duty cycle ≤ 2%.
- b. Guaranteed by design, not subject to production testing.

TYPICAL CHARACTERISTICS (25 °C UNLESS NOTED)

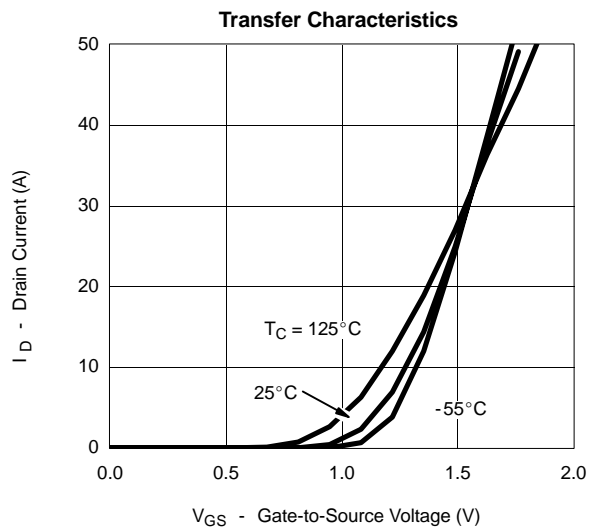
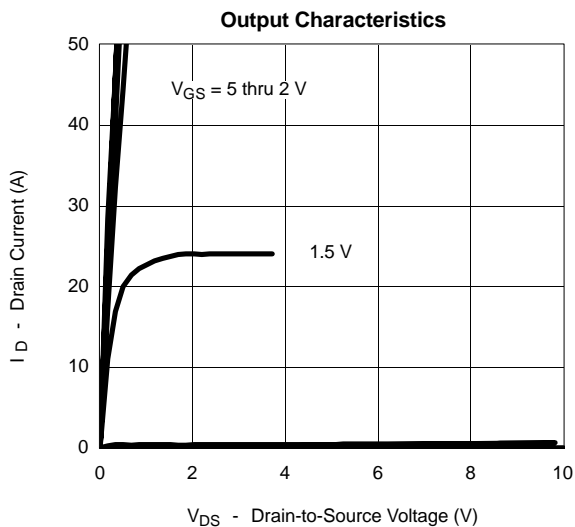



TYPICAL CHARACTERISTICS (25 °C UNLESS NOTED)

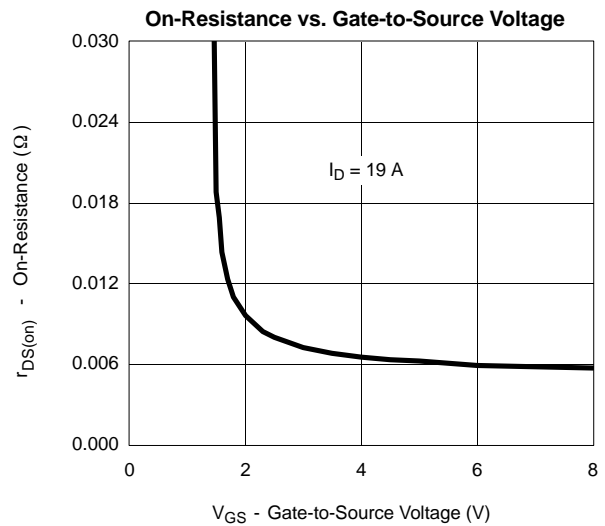
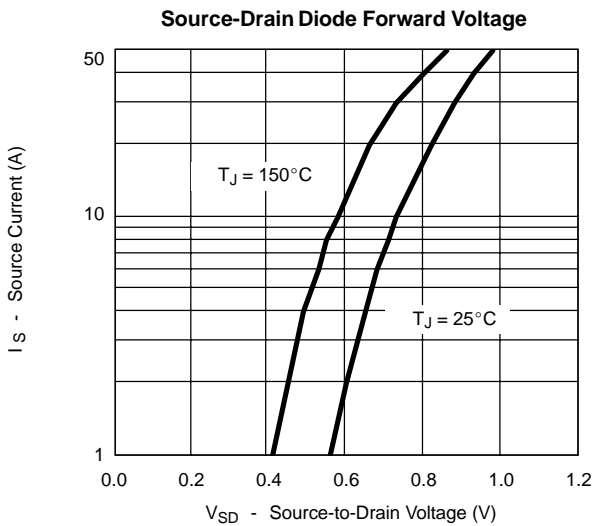
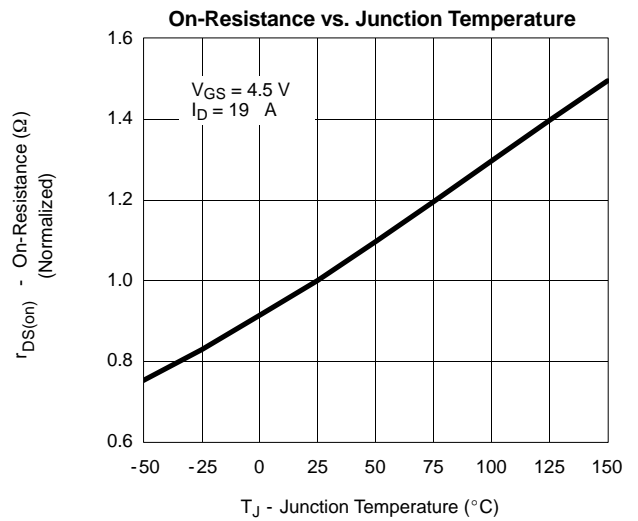
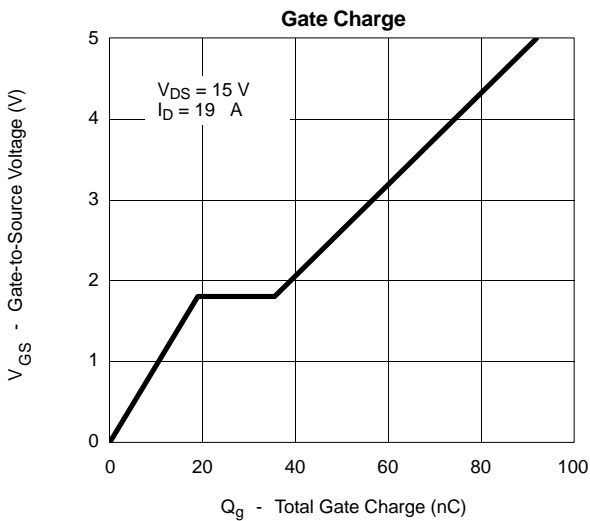
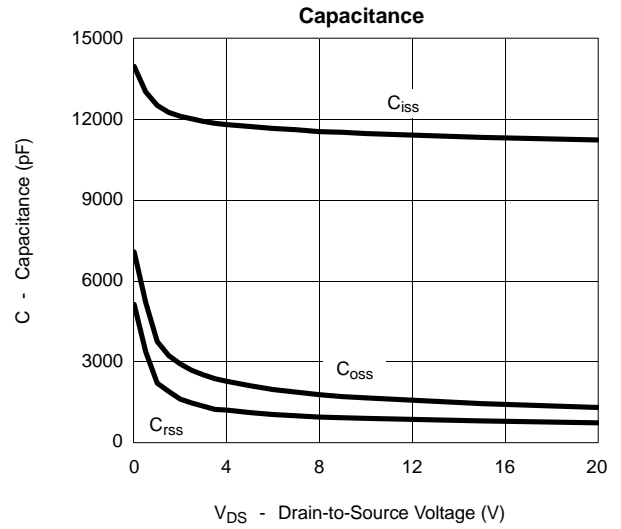
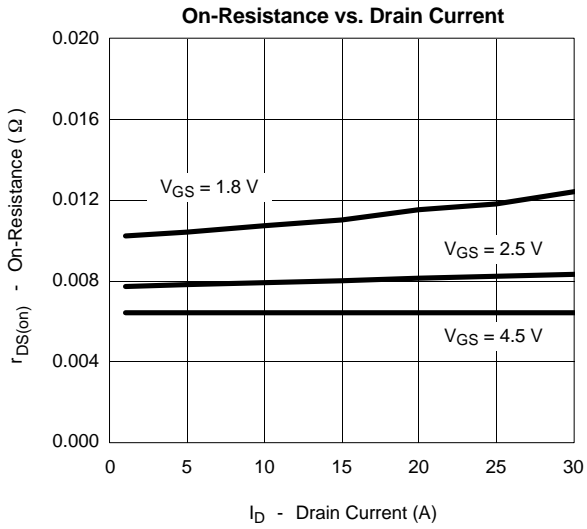

TYPICAL CHARACTERISTICS (25 °C UNLESS NOTED)

